

SOD-323-A PACKAGE OUTLINE DIMENSIONS

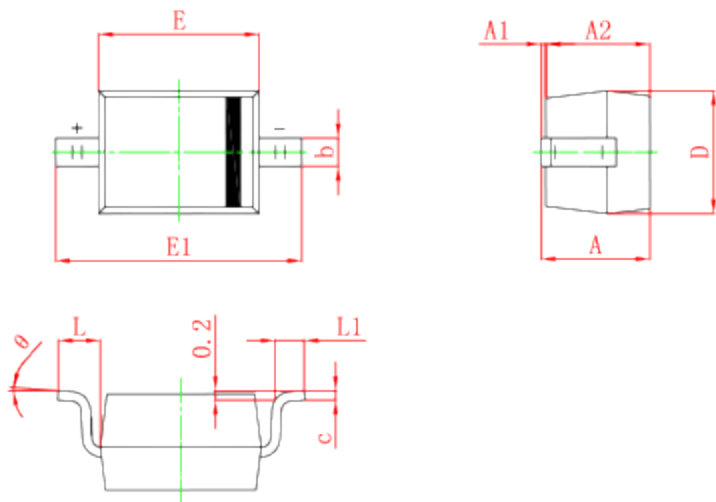

Symbol	Dimensions In Millimeters		Dimensions In Inches	
	Min.	Max.	Min.	Max.
A		1.000		0.039
A1	0.000	0.100	0.000	0.004
A2	0.800	0.900	0.031	0.035
b	0.250	0.350	0.010	0.014
c	0.080	0.150	0.003	0.006
D	1.200	1.400	0.047	0.055
E	1.600	1.800	0.063	0.071
E1	2.500	2.700	0.098	0.106
L	0.475 REF.		0.019 REF.	
L1	0.250	0.400	0.010	0.016
θ	0°	8°	0°	8°

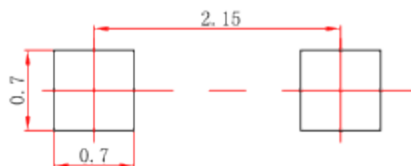

中心距：2.15
 脚宽：0.30
 焊盘宽：0.70
 脚长：0.43
 焊盘长：0.70

技术要求

1. 塑封体尺寸1.70×1.30；
2. 未注公差为：±0.05；
3. 所有单位为：mm。

媒体编号

镀涂

旧底图总号

底图总号

更改标记	数量	更改单号	签名	日期
设计				
审核				
工艺				

SOD-323
焊盘

等级标记

版本号

比例

20:1

日期

签名

标准化
批准

第 1 张 共 1 张

江苏长电科技股份有限公司

格式 (1)

制图:

描图:

幅面: A4

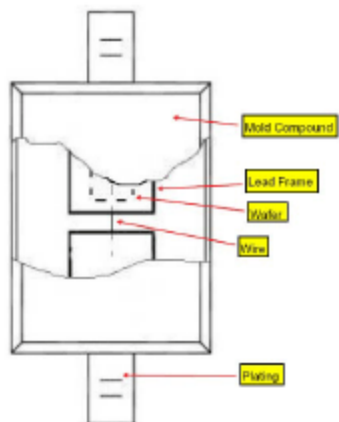

SOD-323 Tape and reel

SOD-323 Embossed Carrier Tape

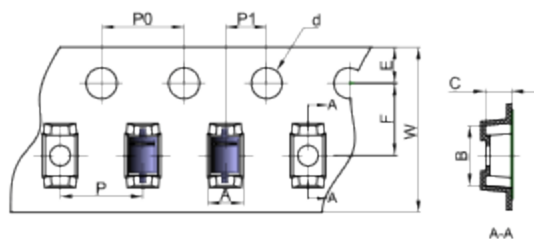

Packaging Description:

SOD-323 parts are shipped in tape. The carrier tape is made from a dissipative (carbon filled) polycarbonate resin. The cover tape is a multilayer film (Heat Activated Adhesive in nature) primarily composed of polyester film, adhesive layer, sealant, and anti-static sprayed agent. These reeled parts in standard option are shipped with 3,000 units per 7" or 17.8cm diameter reel. The reels are clear in color and is made of polystyrene plastic (anti-static coated).

Dimensions are in millimeter

Pkg type	A	B	C	d	E	F	P0	P	P1	W
SOD-323	1.46	2.90	1.25	Ø1.50	1.75	3.50	4.00	4.00	2.00	8.00
(Tolerance)	+/-0.05	+/-0.05	+/-0.05	+/-0.1	+/-0.1	+/-0.1	+/-0.1	+/-0.1	+/-0.1	+0.3/-0.1

SOD-323 Tape Leader and Trailer

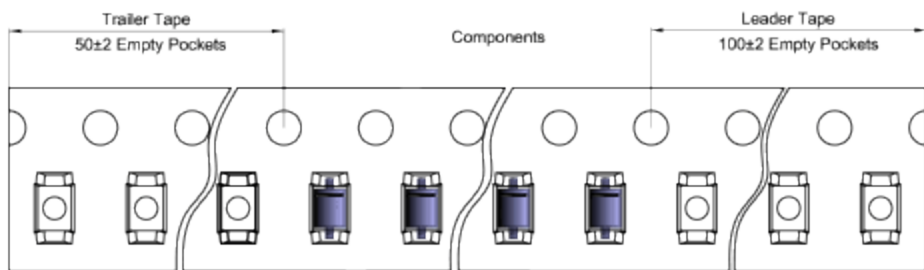

SOD-323 Reel

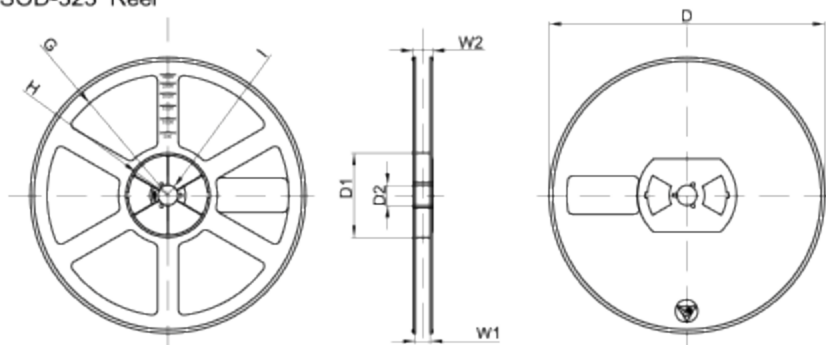

Dimensions are in millimeter

Reel Option	D	D1	D2	G	H	I	W1	W2
7" Dia	Ø178.00	54.40	13.00	R78.00	R25.60	R6.50	9.50	12.30
Tolerance	+/-2	+/-1	+/-1	+/-1	+/-1	+/-1	+/-1	+/-1

REEL	Reel Size	Box	Box Size(mm)	Carton	Carton Size(mm)	G.W.(kg)
3000 pcs	7 inch	45,000 pcs	203×203×195	180,000 pcs	438×438×220	



The bottom gasket

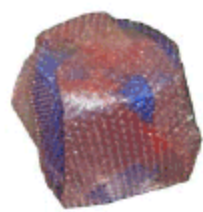

3000 × 15 PCS

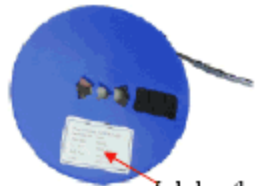

Label on the Reel

3000 × 1 PCS



The top gasket



Seal the box with the tape

Label on the Inner Box

Inner Box: 203 mm × 203mm × 195mm

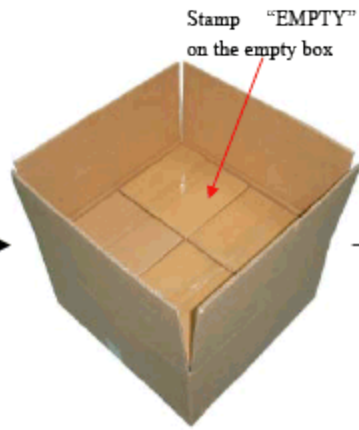

Stamp "EMPTY" on the empty box

Seal the box with the tape

QA Label



Label on the Outer Box

Outer Box: 438 mm × 438mm × 220mm